

APP Quick Start Guide

Solar Camera

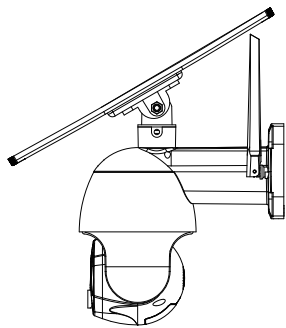

Please read the instructions carefully before using the product and keep it properly.
As the APP version is updated, there will be changes. This manual is for reference.

1. Packing list (please refer to the actual product)

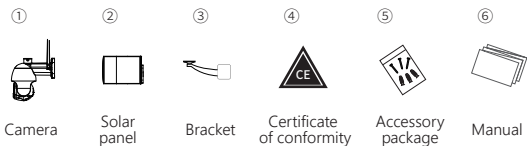

2. Schematic diagram of interface description

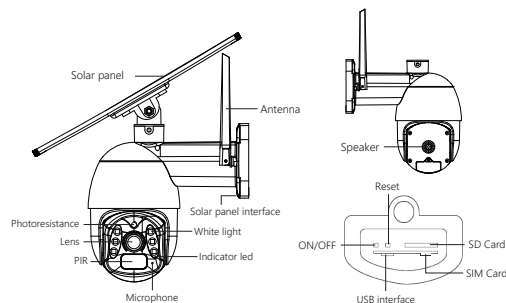

3. Download and install the APP

- Scan the QR code below and click to install or open the mobile app market to search for Tuya Smart.



4. Sign up for Login Account

- Enter your mobile phone number or email address.
- Enter the verification code and set the password, then click login.

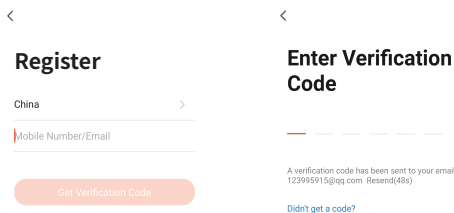

5. Device Connection

Note: This device has built-in battery pack. For the first use, please use the DC 5V2A with USB cable to charge for 10 hours.

- Button:
 - Solar panel On/Off button : Close to USB port, the power stops; Instead, power supplies.
 - On/Off button : Long press for 3 seconds to on or off.
 - Reset button : In the boot state, long press for 5 seconds to reset.
- Indicator light:
 - The red light keeps flashing : Failed to connect to network.
 - The blue lights up : Enter the normal working state after successful registration.
 - The blue light keeps flashing : Connected the network successfully.

Insert the SIM card into the device (the cutaway of SIM card is down and the chip of SIM card is facing the button).
If recording is needed, please insert the SD card (the chip of SD card is facing the USB interface) then wait for the red light to turn blue and keep flashing.

3. Please open the APP as follows:

- Click on "Add".

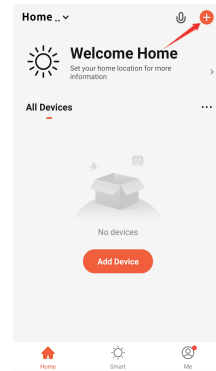

- Click "Scan Code".

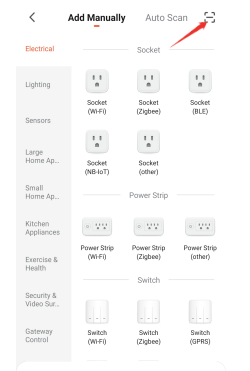

- Scan the QR code on the device.



- The device is being added.

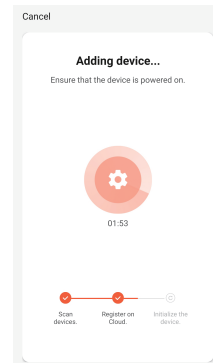

⑤ Successfully added (The blue light is on).

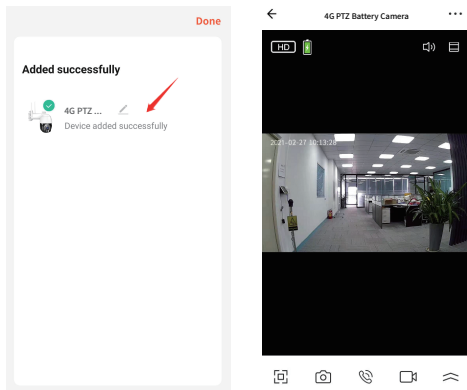

4. A few reminders about the PIR humanoid detection feature.

- * The humanoid detection sensitivity can be set in the device setting. When used in a crowded environment, it is recommended to turn off or set the device to low sensitivity to avoid unnecessary wake-up to prolong the battery service time.
- * Off : In this state, the device will not perform humanoid induction detection.
- * Low : When the device is in hibernation state, it can sense movement detection within 5 meters and trigger to report.
- * Middle : When the device is in hibernation state, it can sense movement detection within 7 meters and trigger to report.
- * High : When the device is in hibernation state, it can sense movement detection within 10 meters and trigger to report.

6. Equipment instructions

① PTZ Control.

* Click the direction to control the vertical and horizontal rotation of the camera.

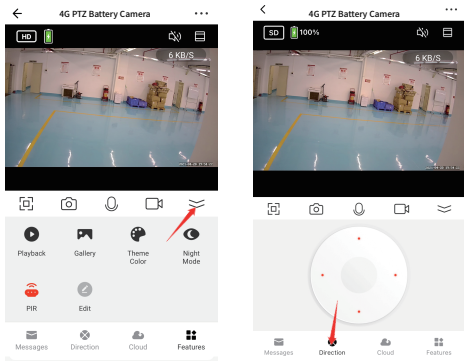

② Click "Playback" then select the date to view all the files and videos of the day.

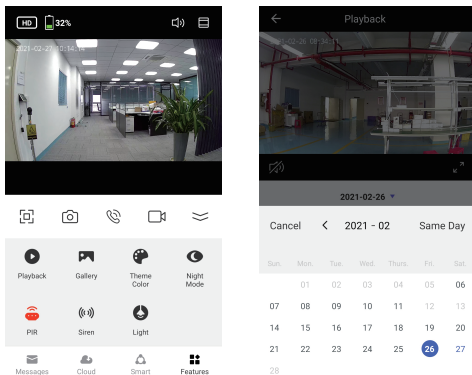

③ Support binding third-party software Alexa & Google to wake device up.

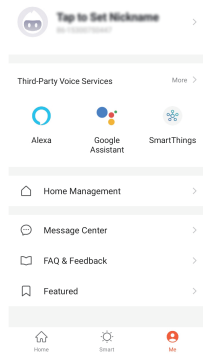

④ Click on Message Notification to view the device's alarm message.

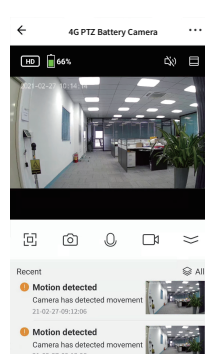

7. Matters needing attention

① PIR is sensitive to cold and hot disturbance, points should be noted during installation:

- * Avoid placing the device in places where the air is churning. For example: air conditioning outlet, equipment cooling outlet, fan surrounding, curtain nearby, etc.
- * Do not install the device directly in front of the glass or mirror.
- * The recommended installation height of the device is about 2.5m-3m.
- * Do not invert the device.

② The device supports battery power, and the battery's service time is affected by the wake-up time and frequency of the device. So the human detection function is suggested to turn off or set the device to low sensitivity when used in a crowded environment, so as to reduce the wake-up times of the device and extend the application time. When the device is low in power, please charge it in time. If the battery is underpowered for a long time, it may cause battery failure.

③ During the installation of the device, please ensure that the 4G network signal is stable at the installation location, especially in remote mountainous areas. It is necessary to check whether the 4G network signal of the operator equipped with the device is stable or not.

④ This device is a low-power intelligent product, which can support APP remote wake up, PIR human detection wake up, button wake up, and automatically enter the sleep state after working for a short time after each wake up.

⑤ To ensure that the device can work normally, please first use the original DC 5V2A charger with USB cable to charge for 10 hours. Do not use a mobile power supply to charge, otherwise it is very likely to cause a short circuit.

8. Problem Resolution

- ① Add failed:
 - * Please check whether the device's blue light is flashing.
 - * Please make sure the network is normal.
- ② Offline equipment:
 - * Please check whether the SIM card can be connected properly.
 - * Please check whether the battery of the device has run out, please try to plug a USB cable for power supply and try again.
- ③ Unable to preview:
 - * The server may be congested, please try to restart the APP.
- ④ No message push:
 - * Please ensure that the APP has notification permission.
 - * Please ensure that the alarm message push switch is turned on in the APP Personal Center Settings.

- ⑤ No video files:
 - * Please insert the SD card before starting up.
 - * Please make sure the device PIR switch is on.
 - * Please make sure the device recording switch is on.
 - * Please check whether the SD card status is normal in the APP. If not, please try to format the SD card.

9. Common Problems

Q: Why does the battery drain so fast?
 A: Frequent triggering of the human detection function in a crowded environment can cause the device to work for a long time and consume power easily. Please try to lower the PIR sensitivity setting; Long time to view video playback file, easy to consume power; Check whether the device signal is stable. If the network is not normal, the device may wake up multiple times and consume power easily. Please try to change the position of the device or change the SIM operator.

Q: How can I confirm that the camera is connected properly?
 A: Please try to actively trigger PIR, wait for 3 seconds, the blue light is on, indicating that the device is connected properly.

材质：105克哑粉纸，风琴折
成品折后净尺寸：75x125mm
成品展开净尺寸：300x125mm

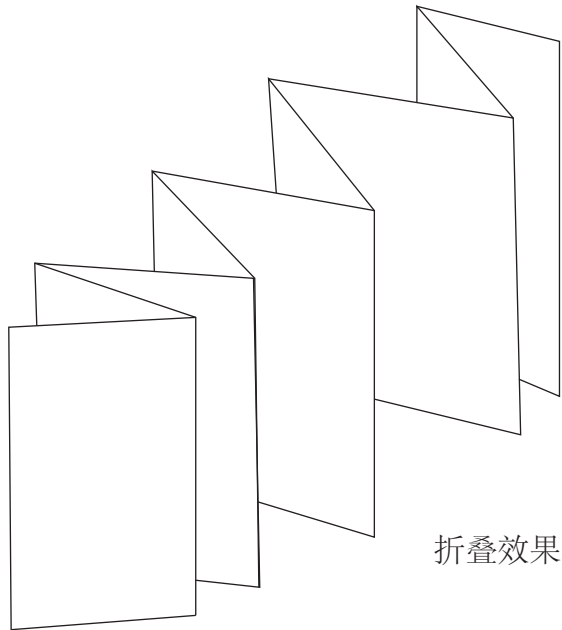

折叠效果